

RAVEN

RTV Device Installation

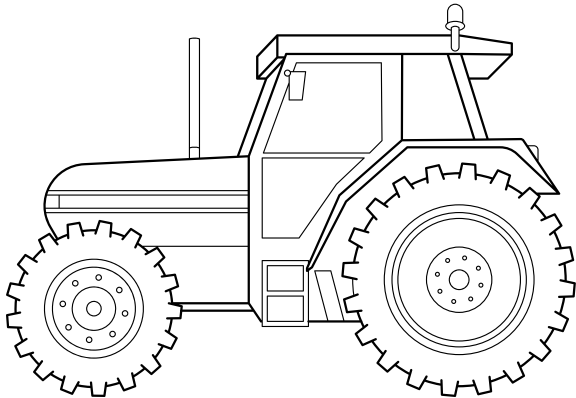
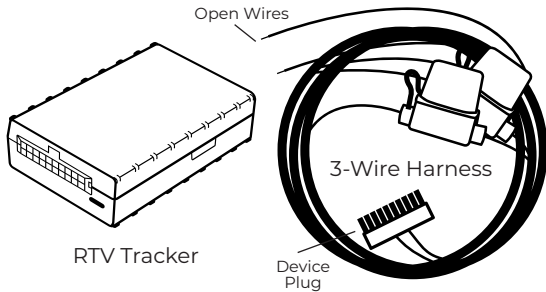

1. Getting Started

- Most wiring installations are connected under the dash, console, or fuse box.

2. Wire Harness Installation

- Take the end with open wires and splice them as follows:
 - Red Wire — 12V Constant Power
 - White Wire — 12V Ignition Switch
 - Black Wire — Chassis Ground
 - Optional Blue Wire — 4-24V Monitored Switch I/O

3. Wire Management

- Run the wire harness to the preferred storage location, directly under the vehicle dash
- Secure the wire harness to ensure safe vehicle and device operation

4. Device Installation

- With "This Side Up" visible, plug in the wire harness into the Device Port
- Carefully align the pins, and push the attachment straight into the device until you hear it lock in place
- Do not push the attachment in at an angle or use too much force

5. Verify Device Installation

- Turn the vehicle's engine to "On"
- Wait for the two LED'S to become solid, if they are flashing or not lighting up, the device is not connected
 - Orange LED — Cellular Service
 - Green LED — GPS Service

6. Look — You're On The Map!

- Log-in to tracking.ravenslingshot.com or open your app and start tracking!





Questions & Troubleshooting

- Call +1-800-243-5435 to talk to a Technical Support Specialist or visit edge.ravenprecision.com and view the Slingshot on Demand training resources



FARM JOURNAL **SCOOP**

RAVEN

-  Hours | 7 AM–5 PM CST | Mon–Fri
-  Sales & Support | (800) 243-5435
-  Login | tracking.ravenslingshot.com
-  Website | ravenprecision.com
-  Email | ATDSupport@ravenind.com

